

SPECIFICATION

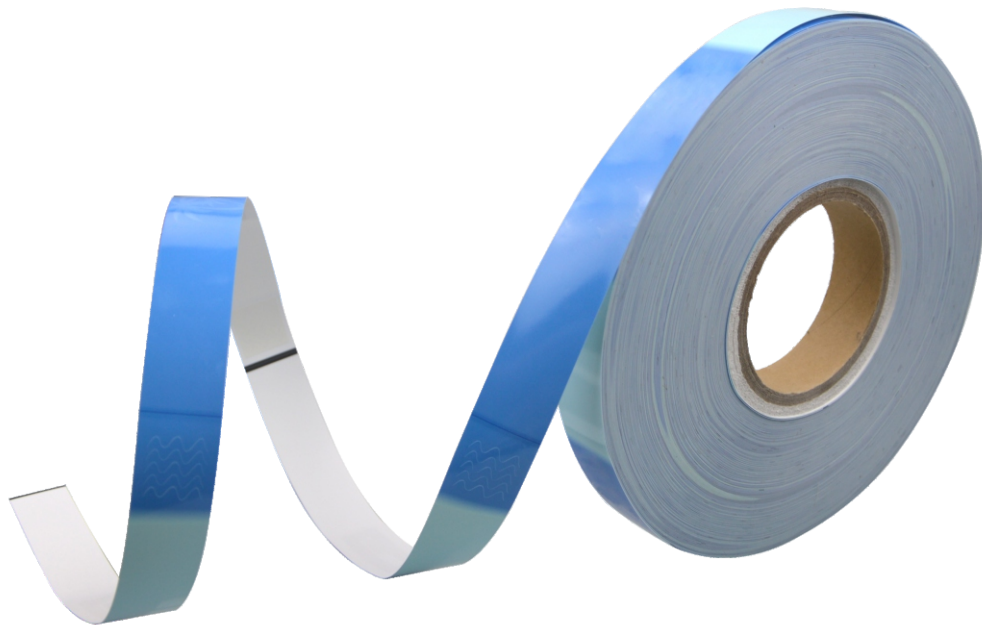

Product name: Thermal Printable RFID Wristband

Item No.: LDF-25425B

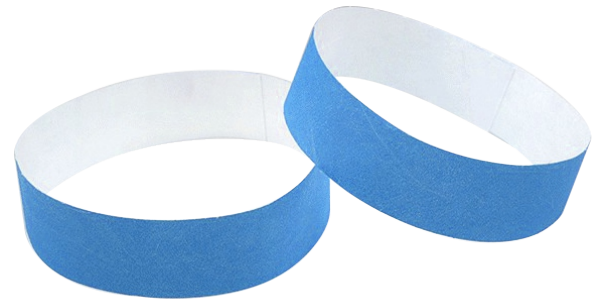
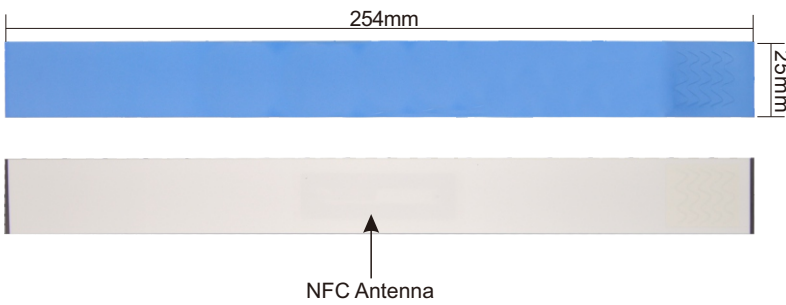

Quick Details

LDF-25425B Thermal printable RFID Wristband is designed in RFID technology with chip and inlay inside. It is compliant with ISO14443A standard and works very well for near field communication(NFC). The wristband is made of special PET paper which can sink into water completely without any wet or fade. It comes in roll package and printable by RFID printer. It is disposable and cost-saving for spa, resorts, water park and moist places.

RFID Parameter

Model No.	LDF-25425B	
Protocol	ISO/IEC 14443A	
Frequency	Worldwide HF 13.56Mhz	
Chip	Compatible MIFARE Classic® 1K	MIFARE Ultralight® C
Memory	UID 4/7Byte	UID 7Byte
	User 1K Byte	User 1536Bit
Read&Write	Supported	
Read Range	0.1-10cm adjustable(reader and environment dependent)	
Data retention	10years	
Programming Cycles	100,000 cycles	

Physical Parameter

Size	254×25mm
Substrate Material	PP paper (Customized)
Antenna Material	Aluminum Etching
Surface Material	Thermal Printable PP paper
Encode	Supported
Installation	Self adhesive
Operating Temperature	-25°C ~ +80°C
Operating Humidity	20% ~ 90%RH
Package	Single or roll
Customized Service	HF Chip / Antenna / Material / Glue / Printing / Craft

Details

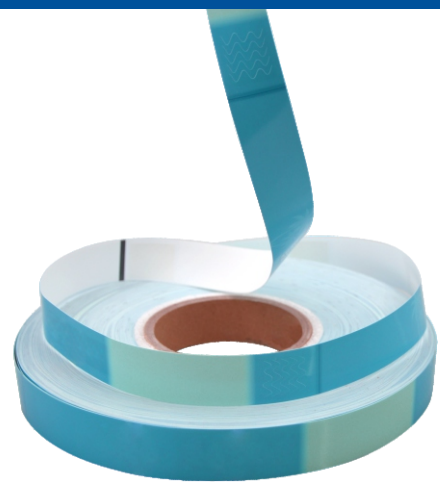
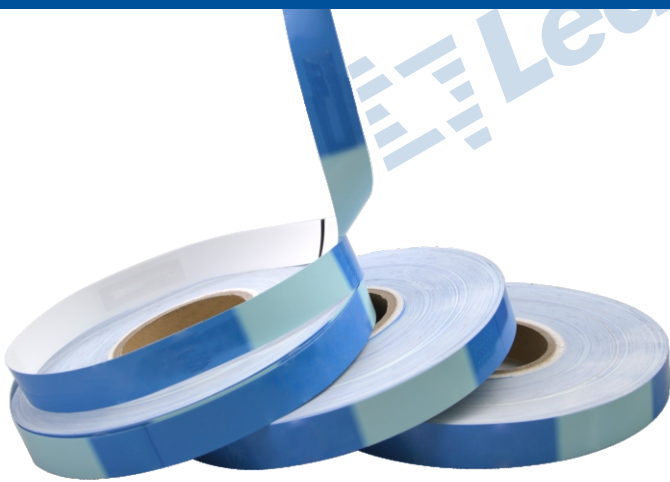

Customized color

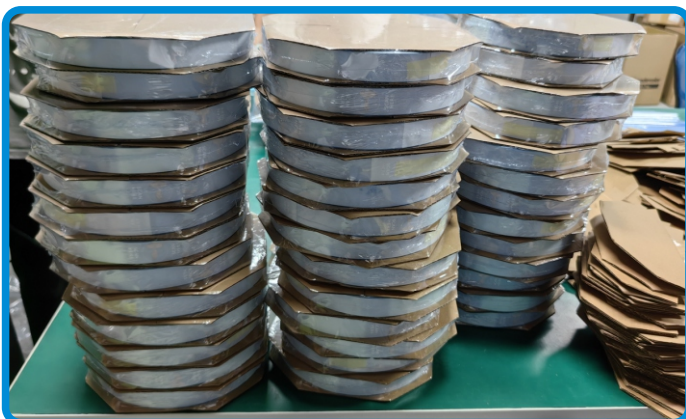

Packing



Size

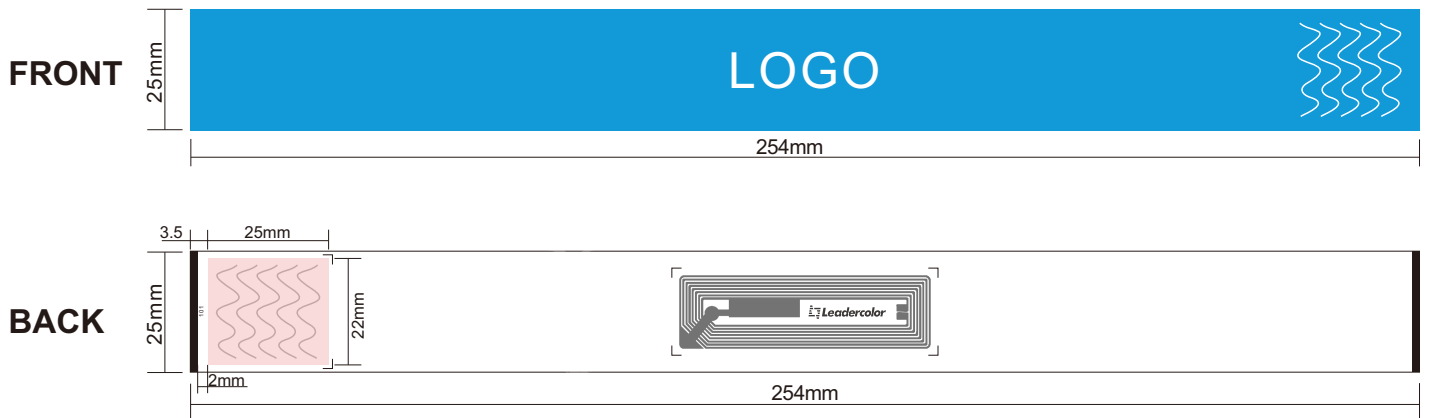

Application

- Big events, concerts, amusement park, tickets.
- Bathing spot management, moist places.
- Hospital

