

# PRODUCT SPECIFICATION

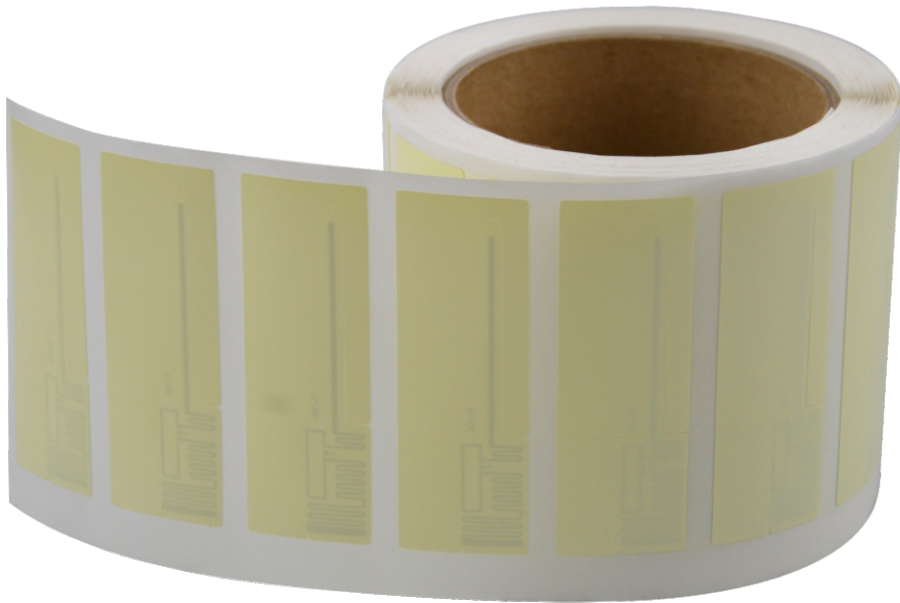

**Product Name:** UHF RFID Tag

**Item No.:** LDR-G201

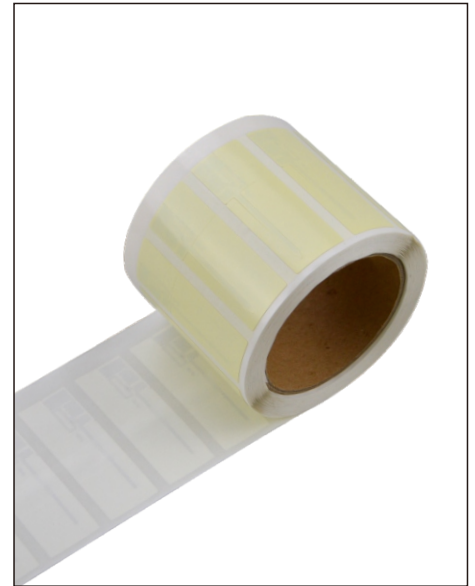

## Quick Details

LDR-G201 UHF RFID Jewelry Label is compliant with EPC C1G2 (ISO18000-6C) standard and it fits for all 860-960mhz UHF RFID readers and antennas. It is designed with long tail for surrounding rings or glasses. It is mainly used for anti-theft system for jewelry shops or luxury accessories etc.

## RFID Parameter

Model No.	LDR-G201
Type	Passive UHF RFID Sticker
Protocol	ISO/IEC 18000-63(formerly18000-6C) and EPC Gen2
Frequency	Worldwide 840-960Mhz
Chip	Impinj/M730
Memory	EPC 128bits/ TID 48bits /User 0bits
Read&Write	Supported
Read Range	1-5meters by handheld reader
Data retention	10years
Programming Cycles	100,000 cycles
Anti-collision	Yes

## Physical Parameter

Size	Folded 26×14mm, tail 46mm(Customized)
Substrate Material	Transparent Release Film
Antenna Material	Aluminum Etching
Surface Material	Glossy PET Waterproof
Installation	Self adhesive
Operating Temperature	-25℃ ~ +65℃
Operating Humidity	20% ~ 90%RH
Customized	Chip / Antenna / Material / Glue / Printing / Craft
Package	2000pcs/roll, printable by RFID printer

## Structure

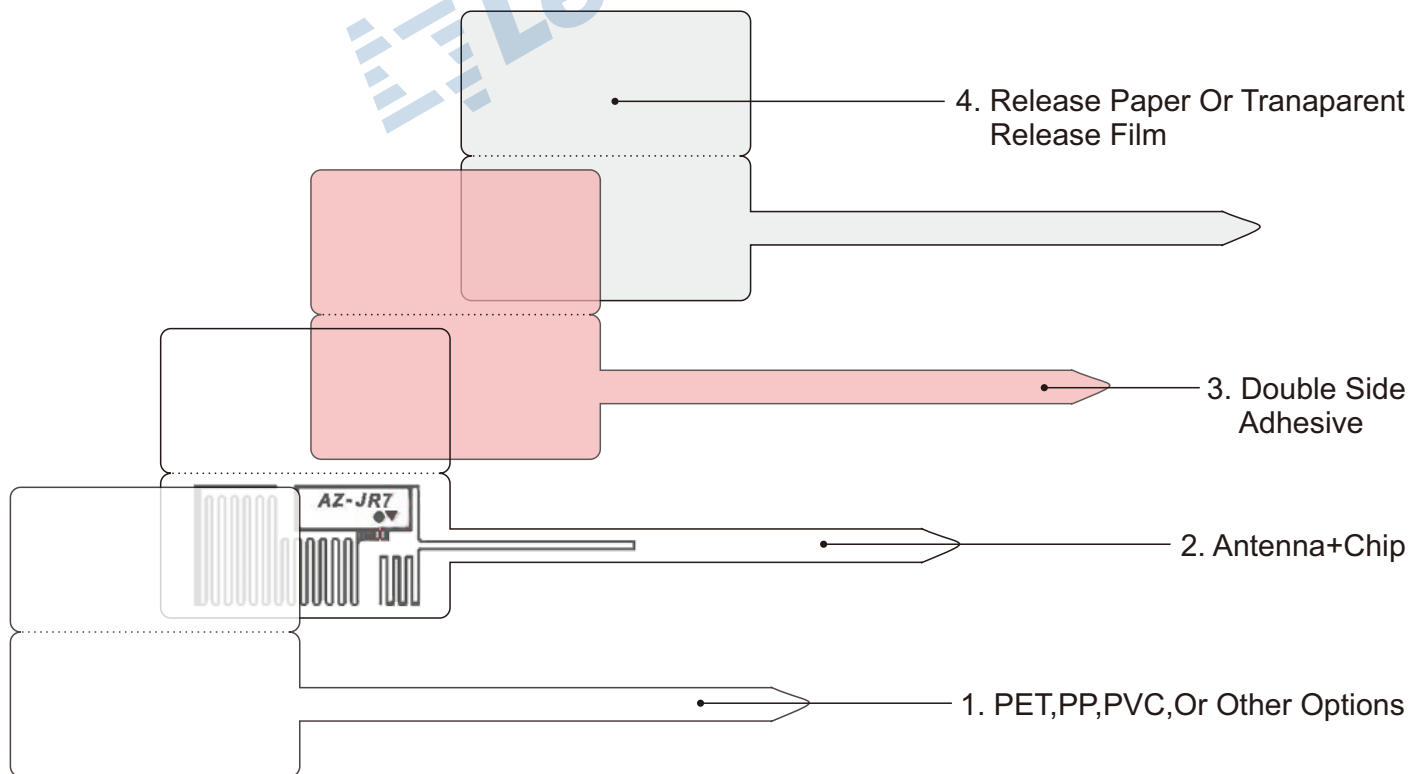

### Front side

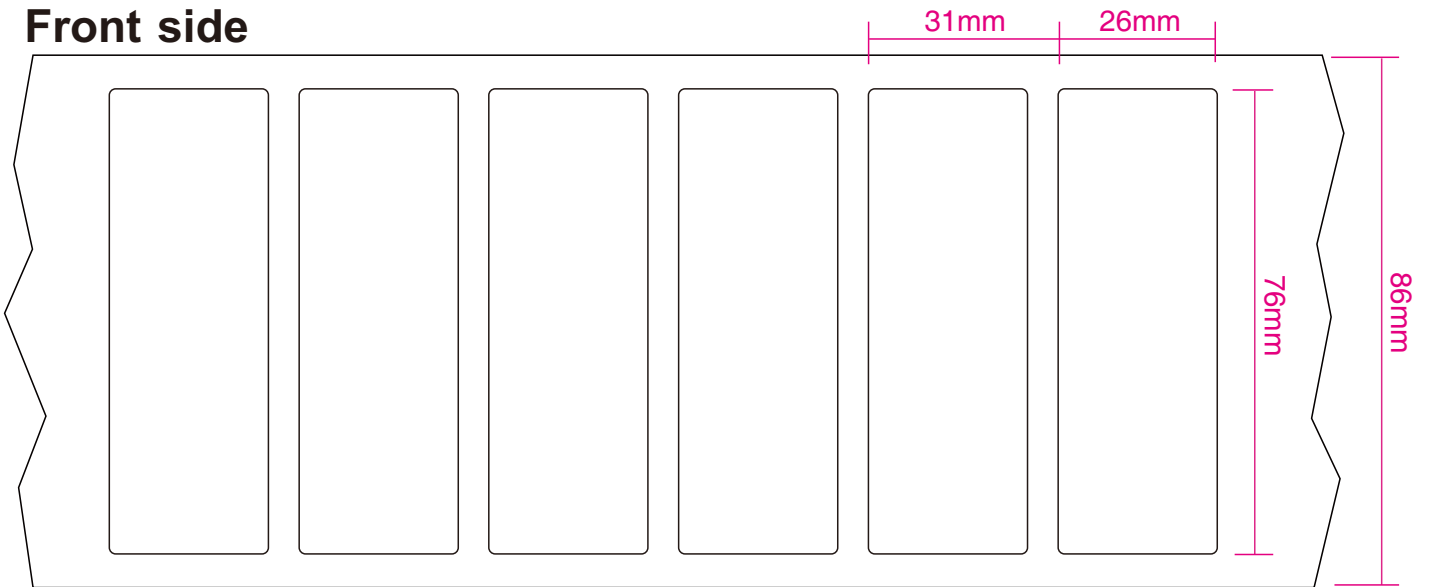

### Back side

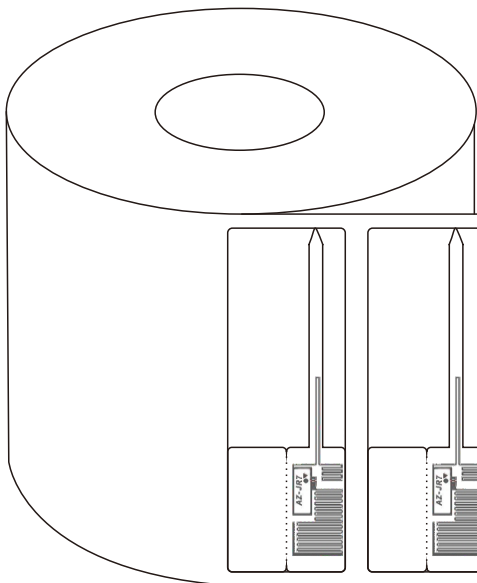
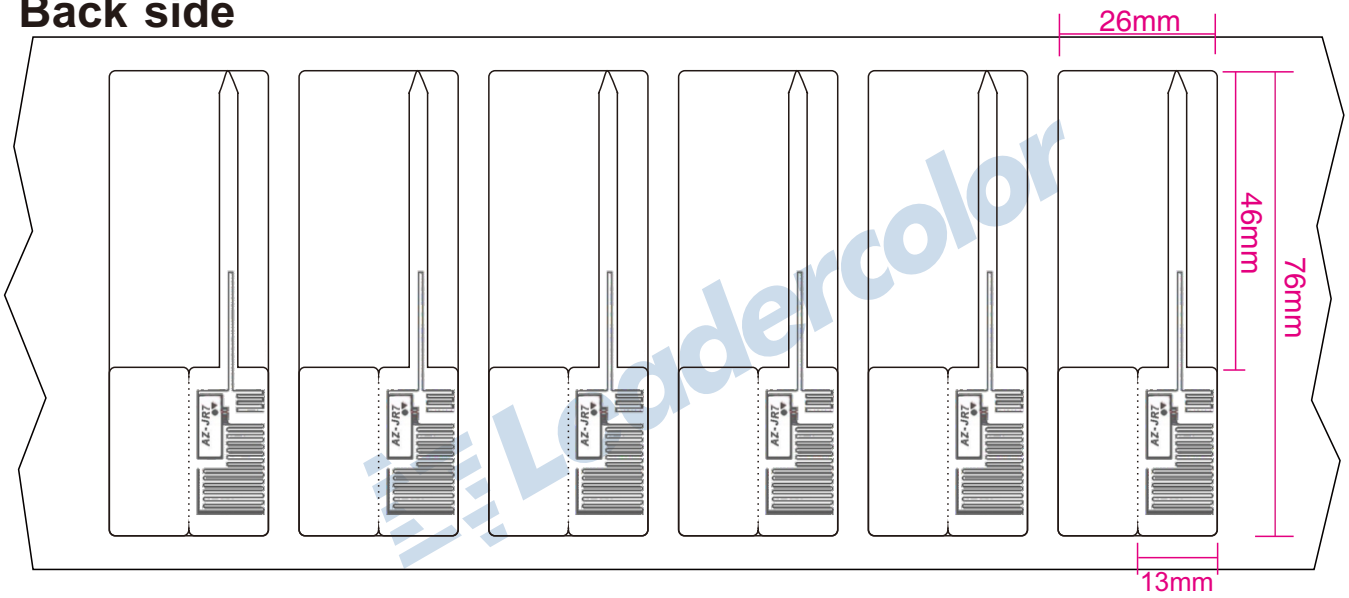

Expand Direction

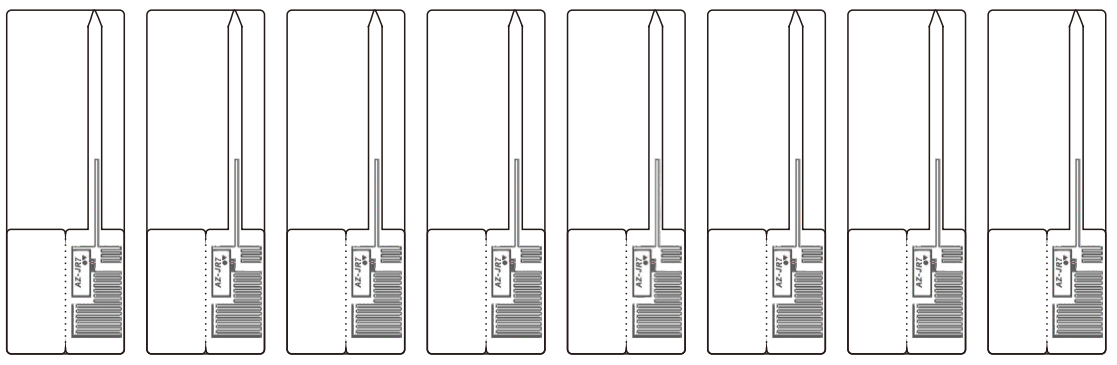





## Size

- Jewelry Management;
- Glasses Management;
- Small device Tracking;

